

# Dim-Out Blind Systems

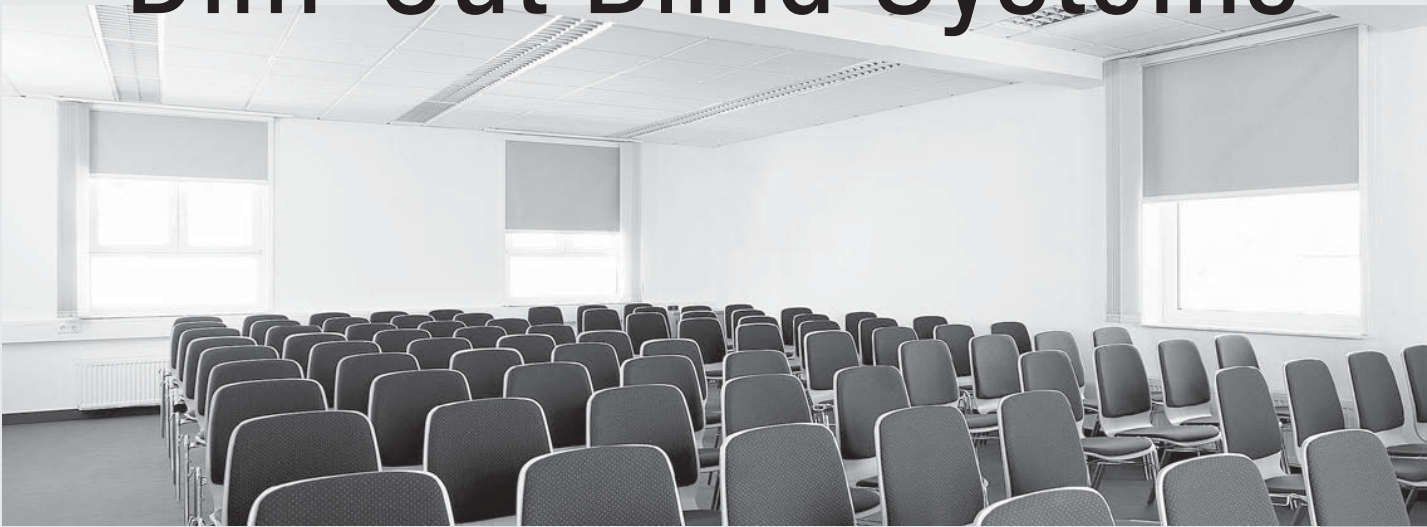

## Motorised Dim-Out Blind System

# Silent Gliss® 4780 Large

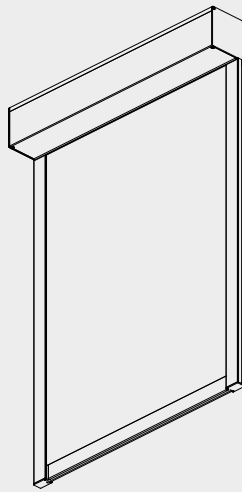

### Product Information

- Technically advanced chain-operated dim-out blind system.
- Up to 3m wide, 3m high or 9m<sup>2</sup> with a maximum weight of 6kg.
- Easy click-in side profiles.
- Inside or outside recess fitting.
- Supplied powder coated black or white.
- Fabrics are 'zipped' into the side profiles.
- Delivered ready-assembled made-to-measure.
- Suitable for inclined positions up to 15° from vertical.
- Applicable with Radio Remote Control System Silent Gliss 9940 and Silent Gliss Move app.



4780

## Profile and Bending Information

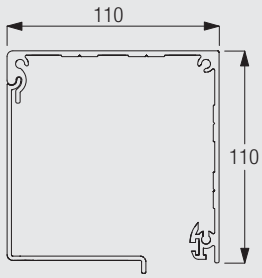

10998-9



Cannot be bent

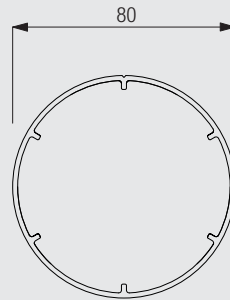

11003



Cannot be bent

## How To Measure

### Inside fitting

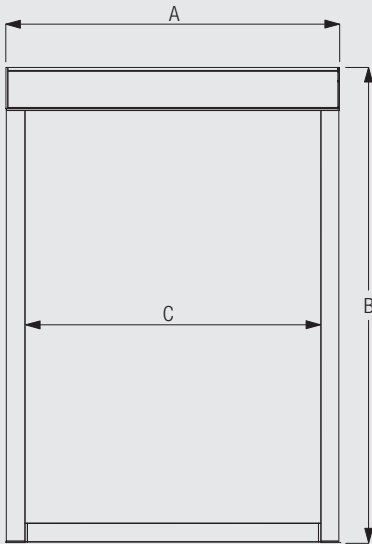

A: System width  
B: System drop  
C: Fabric width



4780

## Face fitting

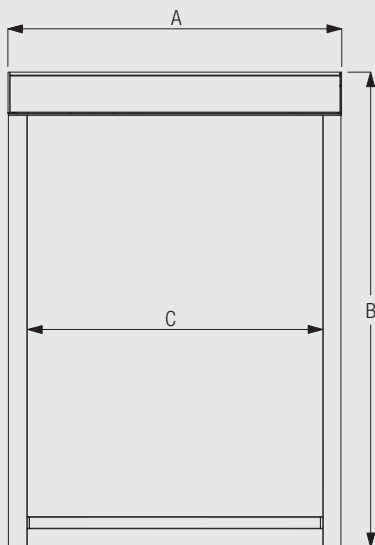

A: System width  
B: System drop  
C: Fabric width

## System Dimensions



3m



65cm



3m



9m<sup>2</sup>



6kg

Please note: The max. system width/drop also depends on the fabric type.

## System Options

### Radio Remote Control System Silent Gliss 9940

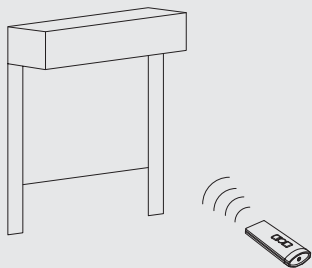

The Silent Gliss motors 10423 and 10523 feature an integrated radio receiver. Combined with the Radio Remote Control System Silent Gliss 9940, this system offers maximum comfort with minimum wiring.

The Silent Gliss motors 10422 and 10522 can be used with Radio Control System 0450 but will use an external radio receiver.

For further details, please refer to catalogue section "Motors & Controls".



4780

## Silent Gliss Move App

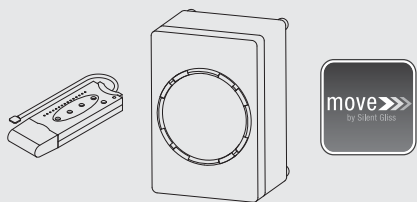

Operation of system with Silent Gliss Move app using a smartphone, tablet or desktop.

Whether at home or on the road, this reliable and intuitive app allows to program automatic opening and closing times. Furthermore, automatic sunrise and sunset time programming and groups and moods are possible.

The app is available for Android, IOS and Windows and can be downloaded in the respective app stores. Additionally, the Move Server Set Silent Gliss 9960 is required.

For further details, please refer to product group "Motors & Controls".

## Fitting Information

### Positioning of drill holes

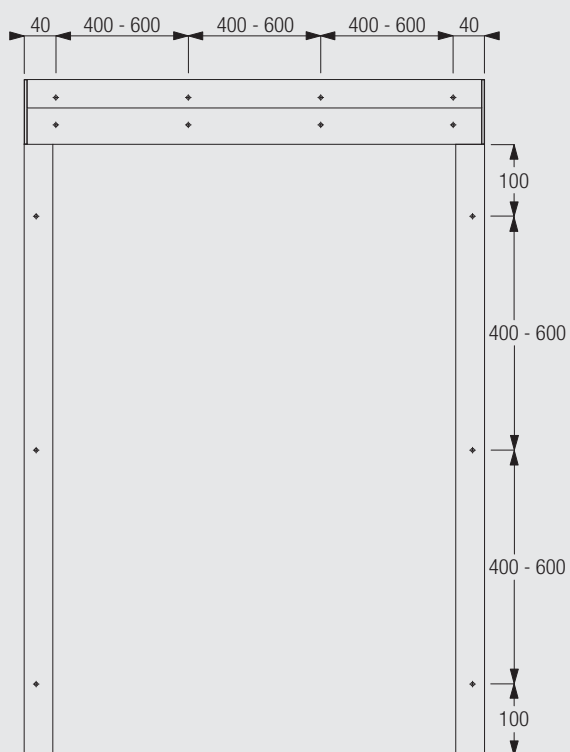

### Side profiles 11001 and 11002

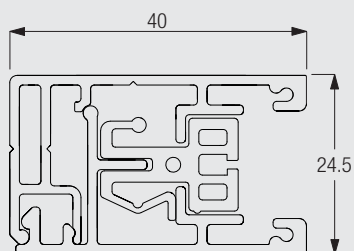

Drawing includes zip profile.

## Fitting Options

### Ceiling fitting with direct mounting

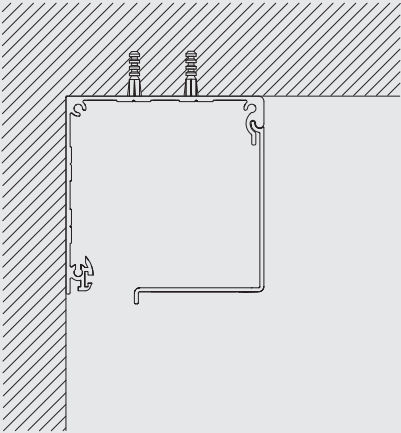

### Wall fitting with direct mounting

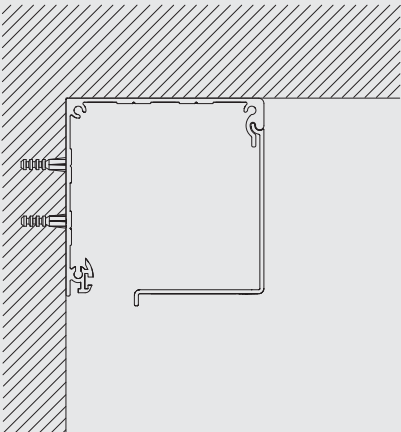

### Recess fitting with direct mounting

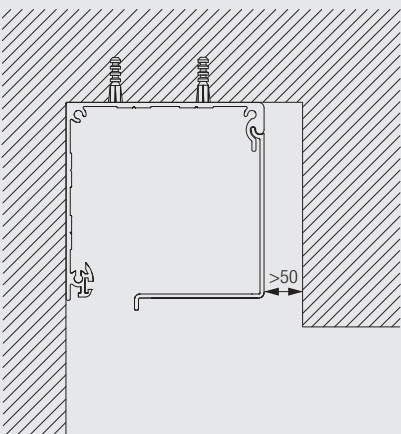

4780

## Standard Accessories

10284	O-Ring		10422	Motor 20-Series, 120 V	
10423	Motor 20-Series, 120 V, radio receiver		10522	Motor 20-Series, 230V	
10523	Motor 20-Series, 230V, radio receiver		10668	Strip (10mm)	
10961	Zip profile		10993	Bottom weight	
11001	Side guide case		11002	Side guide cover	
11003	Profile tube, 80 mm		11008	Side cover left for box, 110 mm	
11009	Side cover right for box, 110 mm		11011	Clip for support	
11013	Clip for motor		11020	Tube adapter support 80 mm	
11022	Tube adapter motor 80 mm		11023	Motor drive 80 mm	
11024	Zip guide		11025	Zip	
11026	Cover left for side guide		11027	Cover right for side guide	
11028	Bottom weight guide left		11029	Bottom weight guide right	
11030	Bottom weight cover		10998-9	Box case and cover, 110 mm	



4780

## Useful Measures

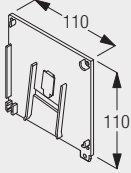
10993	Bottom weight		11008	Side cover left for box, 110 mm	
-------	---------------	---	-------	---------------------------------	---

## Motor & Controls

### Motor Silent Gliss 10522 / 10523 (230 V)

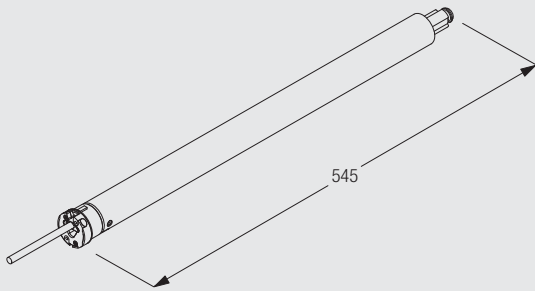

- Voltage: 230 V AC
- Frequency of receiver of motor 10523: 868 / 915 MHz
- Torque: 3Nm
- Speed: 30rpm
- Frequency: 50Hz
- Power: 135W
- Current: 0.60A
- Thermal Overload Protection
- CE Standard
- Cable pluggable
- Max. Weight Capacity: 7.5kg

### Motor Silent Gliss 10422 / 10423 (120 V)

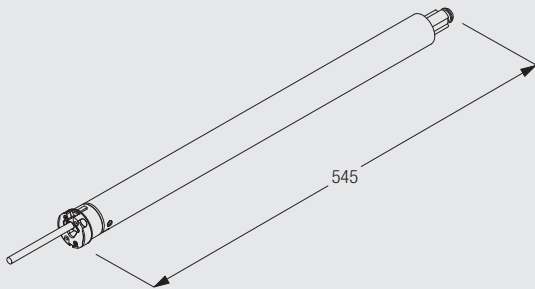

- Voltage: 120 V AC
- Frequency of receiver of motor 10423: 868 / 915 MHz
- Torque: 3Nm
- Speed: 36rpm
- Frequency: 60Hz
- Power: 138W
- Current: 1.15A
- Thermal overload Protection
- CE Standard
- Cable pluggable
- Max. Weight Capacity: 7.5kg

## Operation Methods

### Wall Switch

System to be operated by fixed wall switch.

### Radio Remote Control System Silent Gliss 9940

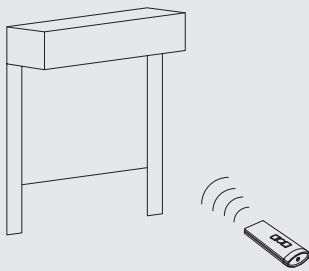

The Silent Gliss motors 10523 and 10423 feature an integrated radio receiver. Combined with the Radio Remote Control System Silent Gliss 9940, this system offers ease of operation with minimum wiring.

The Silent Gliss motors 10422 and 10522 can be used with Radio Control System 0450 but will use an external radio receiver.

For further details, please refer to catalogue section "Motors & Controls".



4780



## Silent Gliss Move App

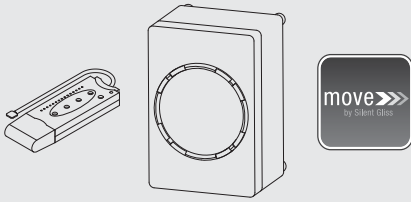

Operation of system with Silent Gliss Move app using a smartphone, tablet or desktop.

Whether at home or on the road, this reliable and intuitive app allows to program automatic opening and closing times. Furthermore, automatic sunrise and sunset time programming and groups and moods are possible.

The app is available for Android, IOS and Windows and can be downloaded in the respective app stores. Additionally, the Move Server Set Silent Gliss 9960 is required.

For further details, please refer to product group "Motors & Controls".







## Wiring and Connections

For other operating / wiring methods, please see section "Motors & Controls".



4780

# Application Chart

Operation	Dimensions					Profile / Cassette			Features / Options			Fitting Options			Fitting Surfaces			System
	min.	max.	max.	m <sup>2</sup> max.	kg max.	Cassette Size (mm)	Profile Number	Profile Diameter (ø mm)	Remote Control System Silent Gliss 9940	Silent Gliss Move applicable	Safety Retainer Set	Ceiling Fitting	Wall Fitting	Recess Fitting	Wood	Concrete	Suspended Ceiling	
	cm	1.6 m	1.6 m	2.5 m <sup>2</sup>	2 kg	73	10532	ø41				●	●	●	●	●	●	4710
	cm	2.2 m	2.4 m	5.3 m <sup>2</sup>	3.7 kg	90	11037	ø60				●	●	●	●	●	●	4730
	cm	3 m	3 m	9 m <sup>2</sup>	6 kg	110	11003	ø80				●	●	●	●	●	●	4740
 230V / 120V	cm	1.6 m	1.6 m	2.5 m <sup>2</sup>	2 kg	73	10532	ø41	●	●		●	●	●	●	●	●	4760
 230V / 120V	cm	2.2 m	2.4 m	5.3 m <sup>2</sup>	3.7 kg	90	11037	ø60	●	●		●	●	●	●	●	●	4770
 230V / 120V	cm	3 m	3 m	9 m <sup>2</sup>	6 kg	110	11003	ø80	●	●		●	●	●	●	●	●	4780



[www.SilentGlissAmerica.com](http://www.SilentGlissAmerica.com)

Silent Gliss Inc  
United States Distribution  
755 East 134th street  
3rd Floor.  
Bronx, NY 10454

Correspondence:  
P.O. Box 592  
New York, Ny 10150

Please call or email  
with any questions or for technical catalogs:  
[info@SilentGlissAmerica.com](mailto:info@SilentGlissAmerica.com)  
Tel: 718-412-9040