

Dim-Out Blind Systems

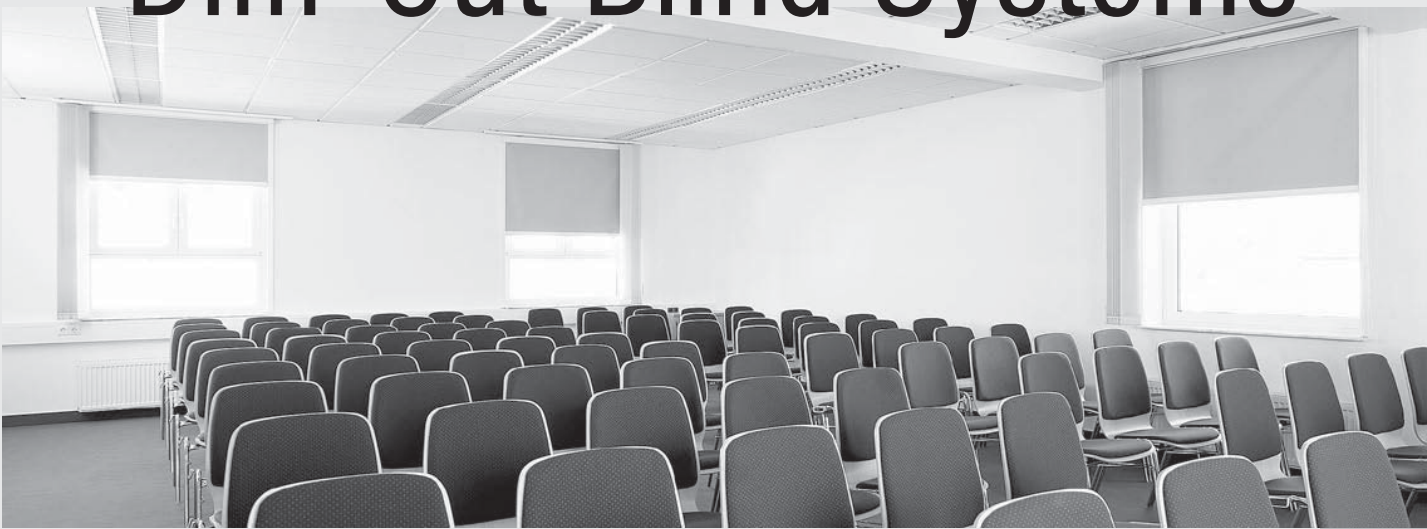

Motorised Dim-Out Blind System

Silent Gliss® 4760 Small

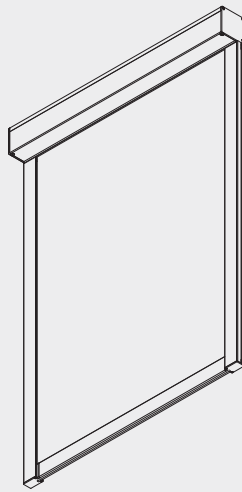

Product Information

- Technically advanced chain-operated dim-out blind system.
- For applications up to 1.6m wide, 1.6m high or 2.5m² with a maximum weight of 2kg.
- Easy click-in side profiles.
- Fabrics are 'zipped' into the side profiles.
- Inside or outside recess fitting.
- Supplied powder coated in black or white.
- Delivered ready-assembled, made-to-measure.
- Suitable for inclined positions up to 15° from vertical.
- Applicable with Radio Remote Control Systems and Silent Gliss Move app.



4760

Profile and Bending Information

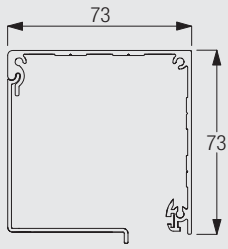

10994-5



Cannot be bent

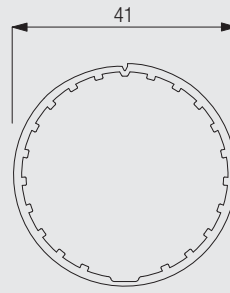

10532



Cannot be bent

How To Measure

Inside fitting

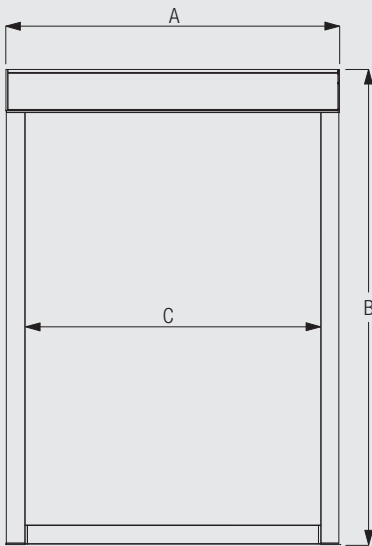

A: System width
B: System drop
C: Fabric width



4760

Face fitting

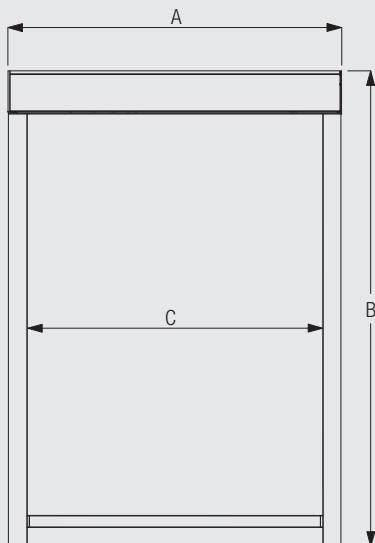

A: System width
 B: System drop
 C: Fabric width

System Dimensions



1.6m



65cm



1.6m



2.5m²



2kg

System Options

Radio Remote Control System Silent Gliss 9940

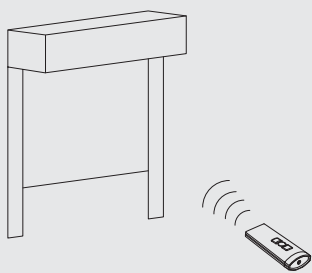

The Silent Gliss motors 10423 and 10523 feature an integrated radio receiver. Combined with the Radio Remote Control System Silent Gliss 9940, this system offers maximum comfort with minimum wiring.

The Silent Gliss motors 10422 and 10522 can be used with Radio Control System 0450 but will use an external radio receiver.

For further details, please refer to catalogue section "Motors & Controls".



4760

Silent Gliss Move App

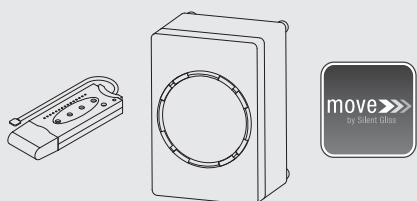

Operation of system with Silent Gliss Move app using a smartphone, tablet or desktop.

Whether at home or on the road, this reliable and intuitive app allows to program automatic opening and closing times. Furthermore, automatic sunrise and sunset time programming and groups and moods are possible.

The app is available for Android, IOS and Windows and can be downloaded in the respective app stores. Additionally, the Move Server Set Silent Gliss 9960 is required.

For further details, please refer to product group "Motors & Controls".

Fitting Information

Positioning of drill holes

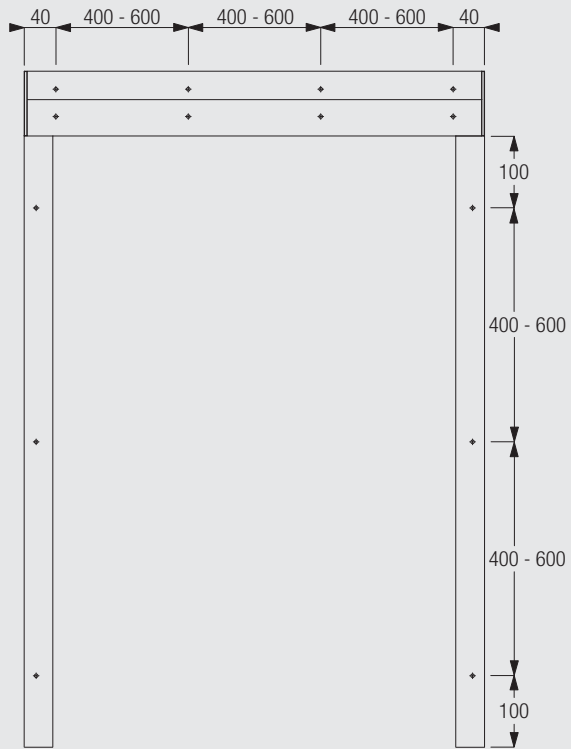

Side profiles 11001 and 11002



4760

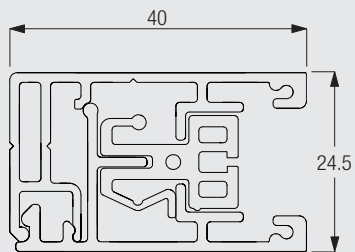

Drawing includes zip profile.

Fitting Options

Ceiling fix with direct mounting

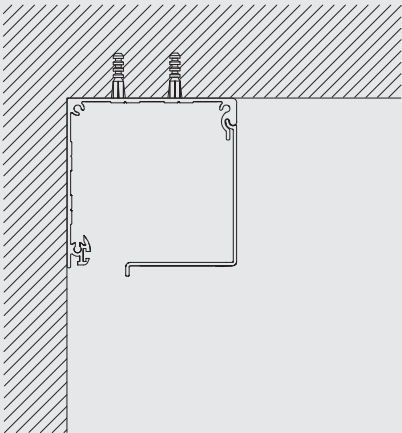

Wall fix with direct mounting

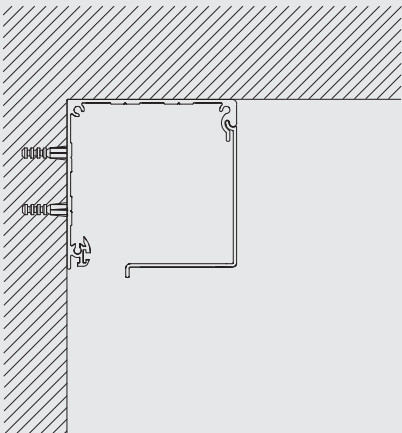

Recess fix with direct mounting

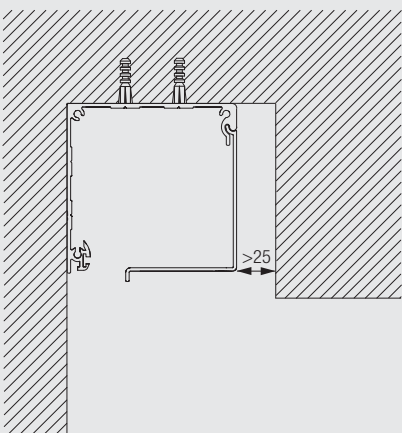

4760





Standard Accessories

10284 O-Ring

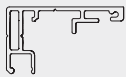

10522 Motor 20-Series, 230V

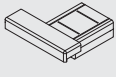

10532	Profile		10961	Zip profile	
10993	Bottom weight		11001	Side guide case	
11002	Side guide cover		11013	Clip for motor	
11024	Zip guide		11026	Cover left for side guide	
11027	Cover right for side guide		11028	Bottom weight guide left	
11029	Bottom weight guide right		11030	Bottom weight cover	
10994-5	Box case and cover, 73 mm				

Optional Accessories

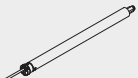
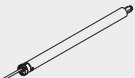
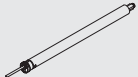
10422	Motor 20-Series, 120 V		10423	Motor 20-Series, 120 V, radio receiver	
10523	Motor 20-Series, 230V, radio receiver				



4760

Useful Measures

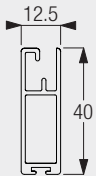
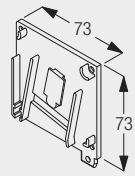
10993	Bottom weight		11004	Side cover left for box, 73 mm	
-------	---------------	-------------------------------------------------------------------------------------	-------	--------------------------------	---------------------------------------------------------------------------------------

Motor & Controls

Motor Silent Gliss 10522 / 10523 (230 V)

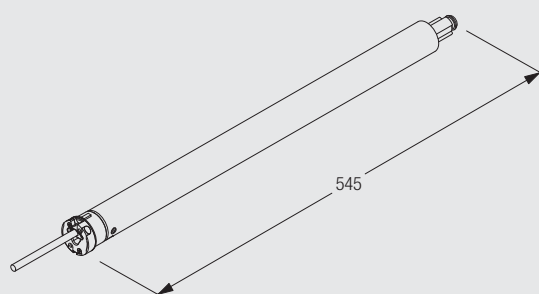

- Voltage: 230 V AC
- Frequency of receiver of motor 10523: 868 / 915 MHz
- Torque: 3 Nm
- Speed: 30 rpm
- Frequency: 50 Hz
- Power: 135 W
- Current: 0.60 A
- Thermal Overload Protection
- CE Standard
- Cable pluggable
- Max. Weight Capacity: 7.5 kg

Motor Silent Gliss 10422 / 10423 (120 V)

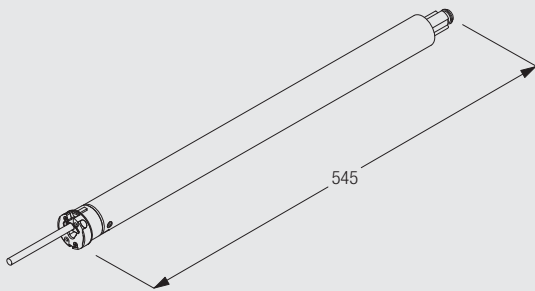

- Voltage: 120 V AC
- Frequency of receiver of motor 10423: 868 / 915 MHz
- Torque: 3 Nm
- Speed: 36 rpm
- Frequency: 60 Hz
- Power: 138 W
- Current: 1.15 A
- Thermal overload Protection
- CE Standard
- Cable pluggable
- Max. Weight Capacity: 7.5 kg

Operation Methods

Wall Switch

System to be operated by fixed wall switch.

Radio Remote Control System Silent Gliss 9940

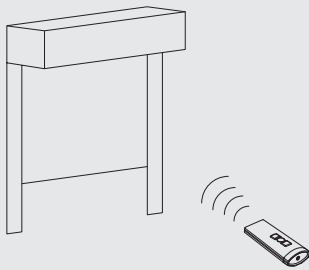

The Silent Gliss motors 10523 and 10423 feature an integrated radio receiver. Combined with the Radio Remote Control System Silent Gliss 9940, this system offers ease of operation with minimum wiring.

The Silent Gliss motors 10422 and 10522 can be used with Radio Control System 0450 but will use an external radio receiver.

For further details, please refer to catalogue section "Motors & Controls".

Silent Gliss Move App

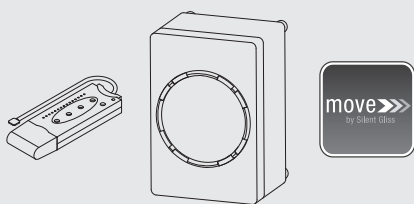

Operation of system with Silent Gliss Move app using a smartphone, tablet or desktop.

Whether at home or on the road, this reliable and intuitive app allows to program automatic opening and closing times. Furthermore, automatic sunrise and sunset time programming and groups and moods are possible.

The app is available for Android, IOS and Windows and can be downloaded in the respective app stores. Additionally, the Move Server Set Silent Gliss 9960 is required.

For further details, please refer to product group "Motors & Controls".



4760

Wiring and Connections

For other operating / wiring methods, please see section "Motors & Controls".

Application Chart

Operation	Dimensions					Profile / Cassette			Features / Options			Fitting Options			Fitting Surfaces			System
	min.	max.	max.	m ² max.	kg max.	Cassette Size (mm)	Profile Number	Profile Diameter (ø mm)	Remote Control System Silent Gliss 9940	Silent Gliss Move applicable	Safety Retainer Set	Ceiling Fitting	Wall Fitting	Recess Fitting	Wood	Concrete	Suspended Ceiling	
	cm	1.6 m	1.6 m	2.5 m ²	2 kg	73	10532	ø41				●	●	●	●	●	●	4710
	cm	2.2 m	2.4 m	5.3 m ²	3.7 kg	90	11037	ø60				●	●	●	●	●	●	4730
	cm	3 m	3 m	9 m ²	6 kg	110	11003	ø80				●	●	●	●	●	●	4740
 230V / 120V	cm	1.6 m	1.6 m	2.5 m ²	2 kg	73	10532	ø41	●	●		●	●	●	●	●	●	4760
 230V / 120V	cm	2.2 m	2.4 m	5.3 m ²	3.7 kg	90	11037	ø60	●	●		●	●	●	●	●	●	4770
 230V / 120V	cm	3 m	3 m	9 m ²	6 kg	110	11003	ø80	●	●		●	●	●	●	●	●	4780



www.SilentGlissAmerica.com

Silent Gliss Inc
United States Distribution
755 East 134th street
3rd Floor.
Bronx, NY 10454

Correspondence:
P.O. Box 592
New York, Ny 10150

Please call or email
with any questions or for technical catalogs:
info@SilentGlissAmerica.com
Tel: 718-412-9040