

# Hand Operated Curtain Track Systems





# Hand Operated Curtain Track System

## Silent Gliss® 1012

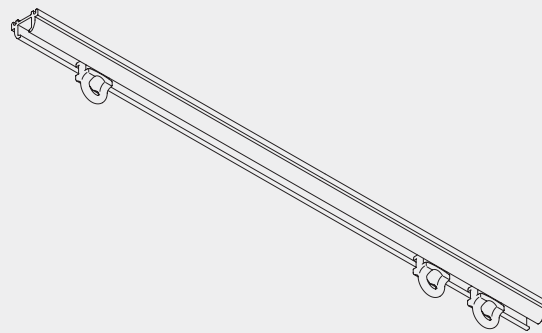

### Product Information

- Hand operated curtain track for light curtains and nets
- Especially suitable for trucks, boats, caravans, etc
- Thin, elegant and bendable ceiling fix profile with special concrete-fixing supports where appropriate
- Quick fixing to wood with special Silent Gliss 7550 centre tool
- Pre-drilled every 4.72 in.
- Standard colours: silver and bronze
- Standard profile length 236.2", (profile connector for longer lengths)
- Can be bent



1012

When splicing on a gradual curve, each side of the track by the splice must have a straight piece of profile of 2" on both Sides (totaling 4" of straight profile)

## Profile, Bending and Specification Information

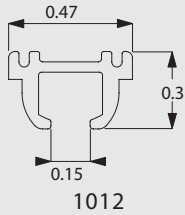

 Standard radius 3.94 in.  
Also as arch.

This is the standard radius which we recommend for optimal operation. The minimum possible radius is 2.36" .

Specification guide - download from [www.silentgliss.co.uk](http://www.silentgliss.co.uk) (password required). (629.92/in)

Silent Gliss 1012 curtain track, hand-drawn, anodised aluminium, complete with gliders 3533 at 16/m. 2 endstops 3016 per length, top fixed to timber (by others) at 14.17 in. centres with special screw 3019. ....Lm. State colour.

## Fitting Information

### Fixing points



The fixing distances are meant as a guide only: they may vary in practice depending on surface and curtain weight.

Silent Gliss Tools 7550 makes fitting to wood more efficient and eliminates damage to the track.

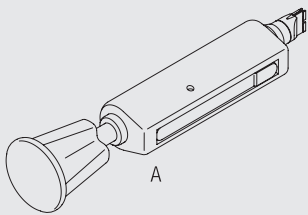

A: Centre tool 7550  
B: Screw 3019 / 0.47"  
C: Screw 3025 / 0.71"

1012

## Fitting Options

### Ceiling fix to timber with single profile

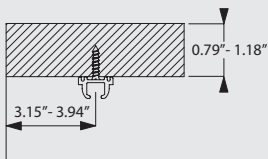

The final distances may be outside of the recommendations above depending on curtain heading, make-up and any obstructions. Batten thickness depends on length of screw.

## Ceiling fix to timber with two or multiple profiles

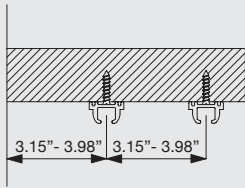

The final distances may be outside of the recommendations above depending on curtain heading, make-up and any obstructions. Batten thickness depends on length of screw.

## Fixing to concrete ceilings with support 3112

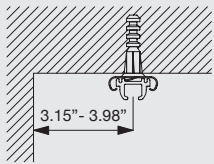

The final distances may be outside of the recommendations above depending on curtain heading, make-up and any obstructions. Batten thickness depends on length of screw.











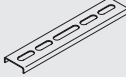

## Standard Accessories

1012	Profile		3016	Endstop	
3019	Special screw - 12mm (standard for timber)		3112	Concrete fixing support (std for concrete)	
3534	Glider 3533 in strip form		7002	Profile protector	



1012

## Optional Accessories

3025	Special screw (18mm)		3032	Spring stop	
3064	Connecting bridge		3070	Twist eye endstop	
3071	Screw twist endstop		3511	Glider	
3533	Glider		3548	Retrofit glider	
3570	Rotating glider		10430	Draw rod with hook, 50cm	
10431	Draw rod with hook, 75cm		10432	Draw rod with hook, 100cm	

10433 Draw rod with hook, 125cm

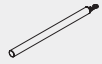

10434 Draw rod with hook, 150cm

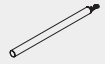

## Useful Information and Sewing Accessories

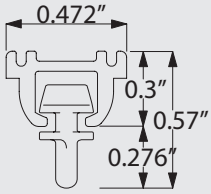
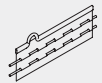

Diagram uses standard 3533/3534 glider and is measured to the inside of the glider eye. For optional gliders substitute dimensions below:

3570 = 0.236"

3548 =

3068 Loop tape



3562 Standard tape

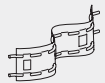

3571 Hook



3582 Hook



3599 Hook



## Useful Measurements



1012

3064 Connecting bridge

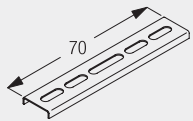



1012

[www.SilentGlissAmerica.com](http://www.SilentGlissAmerica.com)

Silent Gliss Inc  
United States Distribution  
755 East 134th street  
3rd Floor.  
Bronx, NY 10454

Correspondence:  
P.O. Box 592  
New York, Ny 10150

Please call or email  
with any questions or for technical catalogs:  
[info@SilentGlissAmerica.com](mailto:info@SilentGlissAmerica.com)  
Tel: 718-412-9040